

Analyzers and Samplers

Controllers

Sensors

Analyzers

Samplers

Flow

Level

Pressure

Web App

Remote control

Data logging

Accessories

Analyzer

4001Series

Photometric measuring instrument

Chlorine | Chlorine dioxide | Ozone | Peracetic acid

42

ColorMaster

Photometric system for
determination of color

46

ColorTec

Process Analyzer

Aluminum | Ammonia | Cyanides | Chlorides | Chrome VI | Iron | Phosphates | Manganese
Nickel | Nitrites | Copper | Silica | Zinc ... and other

48

UVMeter

Automatic on-line analyser

C.O.D. | Nitrate | Hydrocarbons and Oil in water

52

UV TOCMeter

Automatic on-line analyser

Total Organic Carbon

56

Filtration systems

for analysers

extraction or immersion type

58

Samplers

SP5 B/S/A

Thermostat-controlled and self-draining stationary samplers

61

P6

Portable compact unit

62

TP5 W/C/P

Portable samplers and sampling heads

62

Controllers

Sensors

Analysers

Samplers

Flow

Level

Pressure

Web App

Remote control

Data logging

Accessories

MULTIPARAMETER PHOTOMETRIC SYSTEM

Controllers

Sensors

Analysers

Samplers

Flow

Level

Pressure

Web App

Remote control

Data logging

Accessories

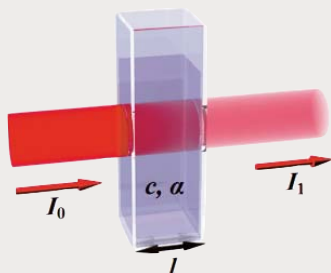

THE PHOTOMETRIC METHOD

In the last decades, Photometry has developed as an essential method of analysis because it enables the "quantitative" determination of both organic and inorganic compounds.

The technique uses the colorimetric methods characteristic of certain analytes, i.e. the properties of certain chemical reagents to develop colour with an intensity proportional to the concentration of a given substance, at a particular wavelength of the spectrum visible between the UV and IR (from 400 to 800 nm).

Compared to UV or IR spectrophotometry, the colorimetric technique has the extraordinary advantage of relying on well-defined linear reactions and with few well-known interfering substances.

The Palin method employs the interactive DPD principle to determine the concentration of certain oxidants such as: Free Chlorine, Total Chlorine, Chlorine Dioxide, Ozone, Peracetic Acid, Bromine, Permanganate etc...

The DPD reacts with the oxidant present in the water, producing almost instantly a pink colour, making sure that all those factors that may affect measurement (pH, μ S, $^{\circ}$ C, organic matter etc.) have no influence on the analytical methodology.

Our photometric system is a reference point in the DPD chlorine control thanks to the combination between reagents and water sampling that guarantees a maximum measurement accuracy, making it a compact analytical mini laboratory, dedicated to the chlorine measurement.

4001 Series

Phases of the measuring cycle

Entry of the sample in the measuring cell for washing/priming

First measurement on the sample as is (Photometric Zero)

Reagent addition using the peristaltic pump

Development of the reaction through stirring

Reading of the colour (Absorbance) the differential measurement between the Zero and the Absorbance is processed by the electronic processor and converted into a concentration value, using specific correlation tables developed in our laboratories



The **electronic controller displays** the measured substance in mg/L and provides whether or not to activate the dosing components designed to control or correct it.

The operating and maintenance costs are very low and, above all, the **system calibration** is performed automatically at each measuring cycle.

User Interface (HMI)

Programming keypad with 4 bubble-keys

STN 240x128 backlit graphic LCD to display measurements (simultaneous measurement and temperature parameter + trend line), digital output status, storage status, faults, photometric measurement phase.

Software & Functions

Data logger of Circular (F.I.F.O.) or Filling type, on an internal 4 Mbit flash memory, equal to 16000 records, with a recording interval from 1 to 99 min.

RS485 serial output for set-up and Real Time status from remote or to download stored data on a PC or laptop (using dedicated software), via MODBUS RTU communication protocol.

Digital input for disabling dosages

Application fields

Industrial applications include the analysis of drinking and waste water as well as the analysis of food products, pharmaceuticals, chemicals etc.

Measuring cell



Photometric measuring cell complete with RS485 serial interface card

Body made of PVC; Plexiglass; Glass

Light-Emitting Diode

Silicon photosensor

Electrode holder cup for housing pH, Rx electrodes, temperature/flow sensors

Hydraulic supply 60 l/h

Max pressure 1 bar

Gravity drain for clean water or for polluted water

Features



Intuitive interface with messages about the status of the method; the large display enables the creation of graphs to display the measurements stored in the internal Data Logger



The peristaltic pump using four pressure points ensures reagent saving



Continuous monitoring of the reagents through level probes. The powder DPD reagent to be diluted before use is an excellent solution for storing the product safely in any place.

MULTIPARAMETER PHOTOMETRIC SYSTEM

Controllers

Sensors

Analysers

Samplers

Flow

Level

Pressure

Web App

Remote control

Data logging

Accessories

Available versions 4001Series

4001-2 Cl ₂ Photometric Free (or Total) Chlorine and Temperature meter	Free Chlorine	0 ÷ 5.0 ppm (0 ÷ 2.0 ppm on request)
	Resolution	0.01 ppm
	Precision	1% f.s. (colorimetric method with DPD)
4001-2 PPA Photometric Peracetic Acid and Temperature meter	Peracetic Acid	0 ÷ 5.0 ppm (0 ÷ 2.0 ppm on request)
	Resolution	0.01 ppm
	Precision	1% f.s. (colorimetric method with DPD)
4001-2 ClO ₂ Photometric Chlorine Dioxide and Temperature meter	Chlorine Dioxide	0 ÷ 5.0 ppm (0 ÷ 2.0 ppm on request)
	Resolution	0.01 ppm
	Precision	1% f.s. (colorimetric method with DPD)
4001-2 O ₃ Photometric Ozone and Temperature meter	Ozone	0 ÷ 5.0 ppm (0 ÷ 2.0 ppm on request)
	Resolution	0.01 ppm
	Precision	1% f.s. (colorimetric method with DPD)
4001-3 Cl ₂ - pH - T Multiparameter control unit for determination of Free Chlorine with photometric method and pH	Free Chlorine	0 ÷ 5.0 ppm (0 ÷ 2.0 ppm on request)
	Resolution	0.01 ppm
	Precision	1% f.s. (colorimetric method with DPD)
	pH	0 ÷ 14.00 pH
	Resolution	0.01 pH
	Precision	1% f.s. (colorimetric method with DPD)
Temperature		0 ÷ 50.0°C – Resol. 0.1°C – Precision 1% f.s.

Other available versions 4001Series

Photometric Bromine meter
Integration with Conductivity measurement

Operating conditions, power supply/electrical protection 4001Series

Operating temperature	0 ÷ 50 °C
Storage and transport	-25 ÷ 65 °C
Humidity	10 ÷ 95% non-condensing
Power supply	100 ÷ 240Vac 50-60Hz
Power consumption	66 W
Electrical protection	UL6950-1 TUV EN60950 EN 55022 Class B EN61000 ENV50204 EN55024

Hardware features, software features and functions 4001Series

Display	LCD STN with white backlight
Resolution	240 x 128 pixels
Languages	Italian, English, French, German, Spanish
Keypad	4 bubble-keys [▼] [▲] [GRAPH/USB] [ESC/MODE] [ENTER/CAL]
Data logger	Internal Flash 4Mbit Memory equal to 16000 records with a recording interval of 01:00 ÷ 99:99 min
Recording method	Circular (F.I.F.O.) or Filling
Display of stored data	in tabular and graphic form (1 for each parameter)
Analogue outputs	1 for each parameter measured (excluding Comb. Chlorine)
Type	0.00 / 4.00 ÷ 20.00 mA galvanically isolated
Programming limits	lower / upper / reverse
Maximum load	500 Ohm
Alarm output	according to NAMUR 2.4 mA (with range 4/20mA)
PID Control	activation on the pH output
Set point relay outputs	two (2) for primary measure + two (2) for pH measure (only mod. 4001-3)
Programming	Hysteresis, Working time and Daily/hourly activation non subject to the measured value: ON – OFF: 00.00 ÷ 05.00 ppm Cl ₂ / 00.00 ÷ 14.00 pH
Working time	000 ÷ 999 sec.
Max resistive load relay	5A at 230Vac
Alarm relay output	Cumulative ON-OFF for: Min/Max, set point delay, faults (no water, reagents finished, projector burned, cell dirty)
Delay time	00:00 ÷ 59:99 mm:ss with minimum steps of 15 seconds
Max resistive load relay	5A at 230Vac
Auxiliary relay output	Programmable as: Set point for Temperature measurement or Timed activation (programmable frequency and activation time)
Max resistive load relay	5A at 230Vac
Digital Input	Clean contact for disabling dosages
RS485 serial output	MODBUS RTU Protocol (1200÷ 38400 Baud Rate) for set-up, Real Time status or downloading data
Dimensions (L x H x P)	598 x 601 x 190 mm
Total width	598 mm
Total height	601 mm (including valves)

Controllers

Sensors

Analysers

Samplers

Flow

Level

Pressure

Web App

Remote control

Data logging

Accessories

PHOTOMETRIC SYSTEM FOR DETERMINATION OF COLOUR

Controllers

Sensors

Analysers

Samplers

Flow

Level

Pressure

Web App

Remote control

Data logging

Accessories



The analytical procedure is used for spring waters, groundwater, water from rivers and lakes and water destined for human consumption after an appropriate treatment. The method can be applied to samples with the base color similar to that of the platinum - cobalt reference solution (yellow - brown).

The color of a water is generally given by organic substances, such as humic and fulvic acids (to which a yellow - brown coloring may be assigned) or by salts of some metals such as iron, copper and manganese.

Observing the light transmitted through a thickness of a few meters, the color of water is of course variable in blue shades. The presence of colored foreign substances causes a variation of color in infinite shades.

The apparent color, due to substances dissolved and suspended into the water, must be distinguished from the real one, only due to dissolved substances.

ColorMaster

User Interface (HMI)

Programming keypad with 4 bubble-keys

STN 128x64 pixels backlit graphic LCD, to display measurements (simultaneous of 4 values + trend line), digital output status, storage status, faults, photometric measurement

Software & Functions

Data Logger (optional) of Circular (F.I.F.O.) or Filling type on internal 4 Mbit Flash memory equal to 16000 records, with recording interval from 1 to 99 min. Data display in graphical and tabular form (1 for each parameter).

RS485 Serial Output (optional) (opto-isolated) for set-up and remote real time acquisition or for downloading the stored data on a portable or desktop PC (using dedicated software), through MODBUS RTU communication protocol at programmable speed 1200 ÷ 38400 Baud Rate.

Hardware features, software features and functions ColorMaster

Absorbance measuring	0 ÷ 500 ABS
Resolution	0.01 ABS
Accuracy	1% f.s.
Temperature measuring	0 ÷ 50.0 °C
Resolution	0.1 °C
Accuracy	1% f.s.
Wavelength	445 nm (others on demand)
Analogue outputs	Four (4) 0/4 ÷ 20 mA galvanically isolated
Quantity	Absorbance, Temperature
Programming limits	lower / upper / reverse
Maximum load	500 Ohm
Alarm output	NAMUR 2.4 mA (with range 4 ÷ 20mA)
Set point relay outputs	Four (4) with direct feeding of users max 100VA Two (2) for Absorbance; One (1) for Temperature; One (1) for Alarm
ON – OFF	0 ÷ 500 ABS
Programming	Daily activation with programming of switching on and off hour. Relay max resistive load 3A at 230Vac
Alarm relay output	closed / open relay max resistive load 3A at 230Vac
ON – OFF	cumulative for min/max, set point delay, faults (no water sample, reagents finished, projector burned, cell dirty)
Delay time	00:00 ÷ 59:99 mm:ss with minimum steps of 15 seconds
Thresholds disabling	active
Digital inputs	Two (2) clean contact and 220 Vac for disabling dosages
Analogue input	One (1) optional 0/4 ÷ 20 mA for auxiliary measurements
Power supply	85 ÷ 265Vac 50-60Hz
Power consumption	30 W
Electrical protection	CEI EN 61010-1
Mounting	Wall
Dimensions (L x H x P)	276 x 514 x 126.5 mm
Mounting depth	126.5 mm
Housing	ABS Grey RAL 7045
Front panel	UV Resistant Polycarbonate
Weight	4 Kg
Operating temperature	0 ÷ 50 °C
Recording interval	-25 ÷ 65 °C
Humidity	10 ÷ 95% non-condensing

Controllers

Sensors

Analysers

Samplers

Flow

Level

Pressure

Web App

Remote control

Data logging

Accessories

PROCESS ANALYZER

Controllers

Sensors

Analysers

Samplers

Flow

Level

Pressure

Web App

Remote control

Data logging

Accessories

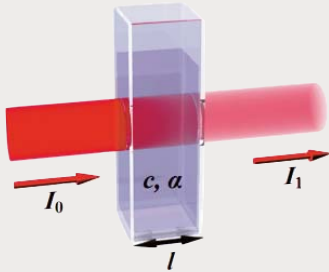

GENERAL PRINCIPLES OF THE LAMBERT-BEER LAW

The Lambert-Beer law is an empirical relation that correlates the amount of light absorbed by a medium to the chemical nature (molar extinction coefficient α), to the concentration (c) and to the thickness of the crossed medium.

When a light beam (monochromatic) of intensity I_0 passes through a layer with the thickness l of the medium, a part of it is absorbed by the medium itself and another part of it is transmitted with residual intensity I_1 .

Analyzer for chemical parameters such as Al, NH_4^+ , Cr^{+6} , PO_4^{3-} , Fe, Mn, SiO_2 and other on request.

ColorTec

It consists of two sections, hydraulic/analytical and electronics. These two sections are separated from each other so as to ensure efficiency and durability of all the parts

User Interface (HMI)

The user interface consists of an **industrial PC with touch screen**.

Software & Functions

The **control software**, simple and intuitive, allows the immediate understanding of all the commands and functions.

It is possible to perform measurements at programmed intervals, at a specific time or at an external event.

The software archives and makes available in graphical form all the measurements.

The instrument is **designed for connection to an existing LAN**.

Phases of the measuring cycle

The analyzer automatically reproduces the colorimetric determination, as well as carried out in the laboratory, according to the following steps:

Emptying of the reading cell

The cell is emptied by use of an air pump

Zero measurement

The fresh sample is inputted and the instrument performs a first reading of the sample as received (or, if required by the methodology, with the addition of reagents) to acquire the photometric Zero.

Emptying of the reading cell

The cell is emptied again



Colouring reagent(s) and sample dosing

Depending on the specific methodology, one or more colorimetric reagents are dosed

Absorbance measurement and calculation of the concentration

Reading of light intensity value of the coloured liquid after proper mixing of the reagents

Emptying, rinsing of the hydraulic circuit and of the measuring cell

The reading cell is emptied and flushed with cleaning water together with the entire hydraulic circuit. At the end the reading cell will be left full of clean water until the next measurement.

Calibration

The instrument is supplied with factory calibration, performed using certified standard solutions; however, the user has the possibility to change this calibration by acting directly on the coefficient K (1,000 by default).

The coefficient "k" can be automatically determined by the instrument after making a measurement of known value, set in the "STANDARD" box.

Alternatively, the calibration can be changed by using an ABS/PPM correlation table (up to a maximum of 50 points).

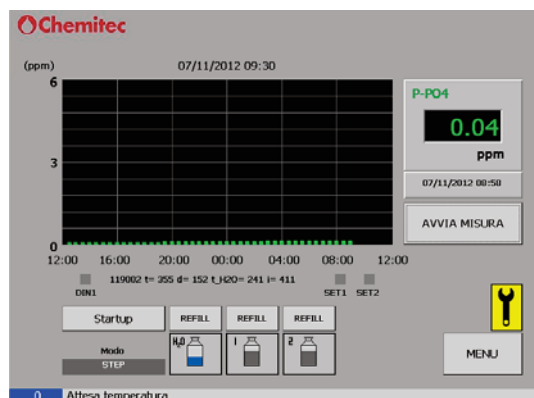

1 Touch screen controller

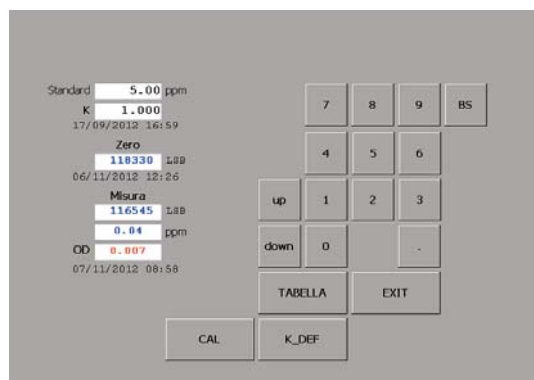

System composition

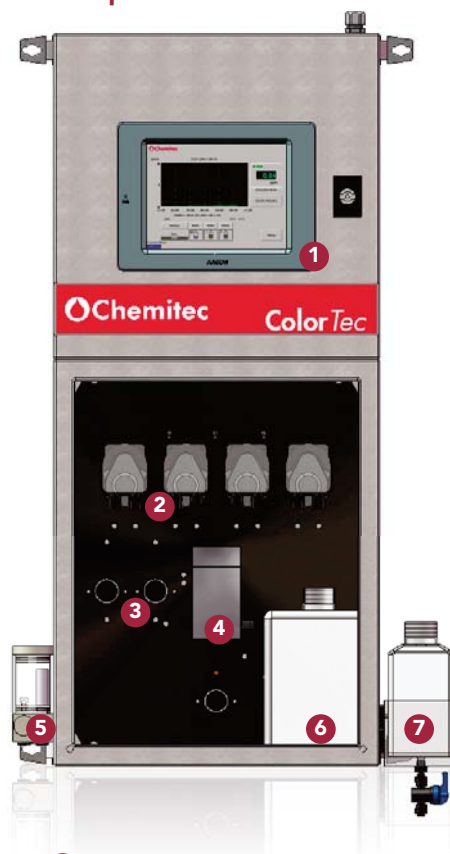

- 1 Touch screen controller
- 2 Peristaltic pump for dosing reagents / sample / cleaning water
- 3 Sample/Cleaning water solenoid valves
- 4 Measuring cell
- 5 Sample inflow cell
- 6 Cleaning water tank
- 7 Reagent bottles

PROCESS ANALYZER

Controllers

Sensors

Analysers

Samplers

Flow

Level

Pressure

Web App

Remote control

Data logging

Accessories

Measuring cell

The measuring cell consists of a thermostated aluminum coil inside of which is contained a test tube into which flows the liquid to be analysed.

A projector with LED sends a light beam that passes through the medium, while a photodiode, located on the opposite side of the projector relative to liquid to be analysed, receives the signal given by the emitted light beam, according to the Lambert-Beer law.

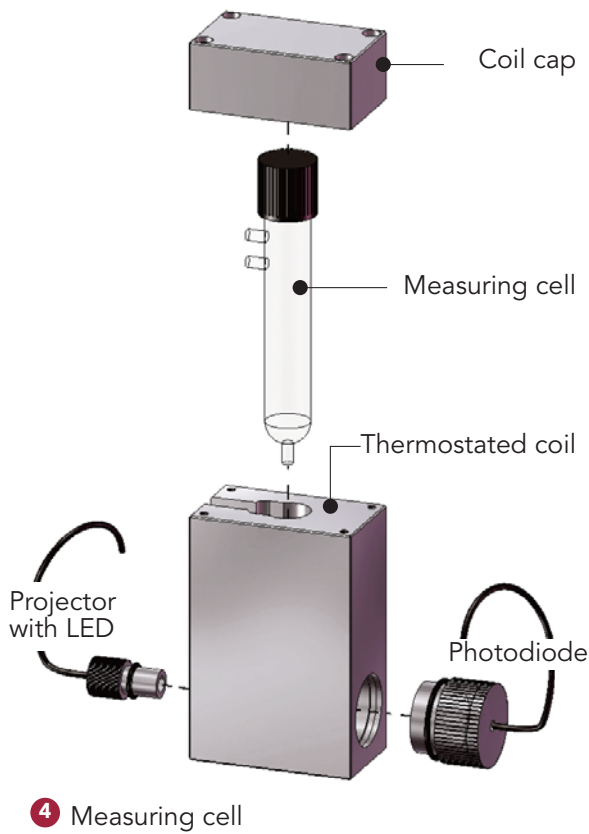

Filtering system (OPTIONAL)

In particular applications, it is necessary to perform a pretreatment of the sample to remove suspended particles present into the liquid to be analysed.

Chemitec can provide a filtration system at 100 μm , complete with self-cleaning system (with compressed air) disposed on perforated panel to be installed comfortably on the wall.

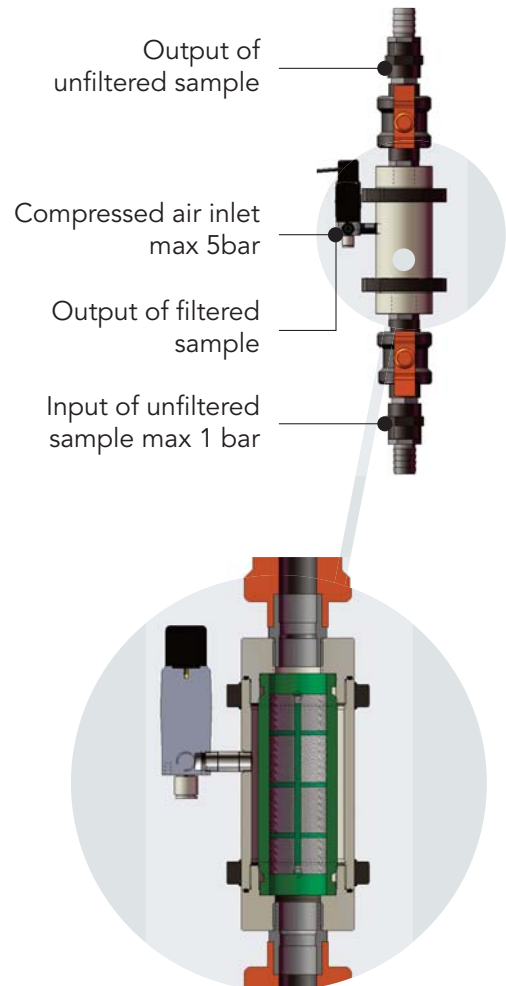

Hardware features, software features and functions ColorTec

Photometric range	2.5 Optical density
Precision	± 3 % of the full scale
Repeatability	90 % of the measure
Frequency of the analysis	Hourly or by step (20 minutes minimum)
Turbidity of the sample	Max 10 FTU/NTU. For higher turb. it's recommended to use the filtration syst. (optional)
Liquid pressure	0.1 ÷ 0.3 Atm. stable
H ₂ O or air pressure for filter washing	0.1 ÷ 0.5 Atm. stable
Measuring sensor	Standard Silicon sensor with 17-bit digital converter
Wave length	445 ÷ 800 nm with led
Light source	Led
Reading cell	made of PIREX® Ø 16 mm
Mixer	Reaction Coil in thermostated Aluminum
Dosage of reagents	Peristaltic pumps with variable speed
Hydraulic system cleaning	Automatic washing with distilled H ₂ O
Visualization	LCD 8.4 colour display
Data insertion	Resistive TOUCH SCREEN
Computer CPU	Atom with 4GB flash disk
Access to the system	through password
Archive	Circular, with date and value storage
Visualization of measures	Via SW it is possible to view the daily, weekly and / or monthly chart of all the archived measures
Data download	Possible via USB mass storage device
Set-Points	Two (2) ON-OFF programmable as min. or max. via SW
Output relay contacts	Max 2A 220V resistive load
Current output	0/4 ÷ 20 mA programmable via software
Load	maximum 500 ohm
Serial interface	Two (2) ON-OFF programmable as min. or max. via SW
Calibration	Manual with activation from menu
Calibration curve	Creation of the calibration curve using a table from 2 to 50 points in which it is possible to enter arbitrary values
Dimensions (L x H x P)	1000 x 400 x 200 mm
Weight	45 Kg
Power supply	220 Vac 50 Hz (110Vac on request)
Power consumption	100 W max

Controllers

Sensors

Analysers

Samplers

Flow

Level

Pressure

Web App

Remote control

Data logging

Accessories

AUTOMATIC ON-LINE ANALYZERS

Controllers

Sensors

Analysers

Samplers

Flow

Level

Pressure

Web App

Remote control

Data logging

Accessories

Measurements

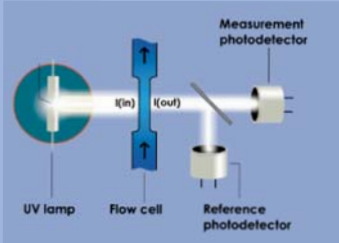

COD

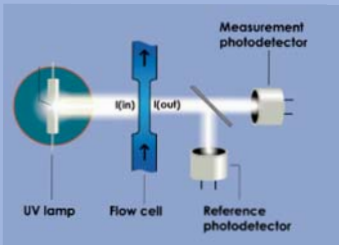

Nitrates

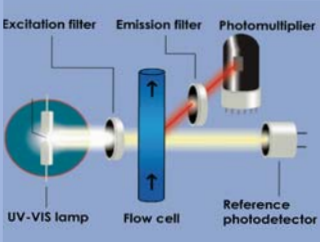

Hydrocarbons; Oils in water

UVMeter



Control with
**Touch Screen
Display**



Long life **UV
Lamp** - 10 years
of operation



**Internal Data
Logger** with data
download via
RS 232 (optional)

Features

- Compact size
- No reagent (except for NaOH for Ammonia)
- Built-in automatic washing system
- Extremely fast response time
- The running costs are very low as the UV spectrophotometric measurement principle does not require the use of analysis reagents
- Extremely simple hydraulic system with pipes with large diameter
- The automatic cleaning system keeps the measuring cell clean for long periods with no need for intervention. The tank only needs to be filled with cleaning solution (5% sulphuric acid) once a month
- Built-in peristaltic pump for sampling

C.O.D. ANALYZER

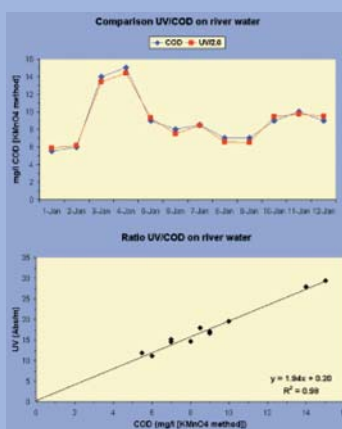
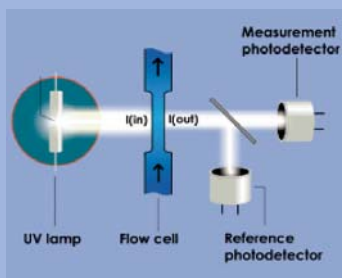

The measuring principle is based on the intense UV absorption of the organic molecules at 254 nm in accordance with the Lambert-Beer law:

$$[C] = k \cdot \log \left(\frac{I_{in}}{I_{out}} \right)$$

[C]: sample concentration

k: extinction coefficient

I_{in} : intensity of light input sample

I_{out} : intensity of light output sample

Turbidity, organic substances, suspended solids or dirt into the measuring cell are automatically compensated by means of a differential measurement with a second detector at a different wavelength.

Compliant with AFNOR X PT 90-210 – DIN38404-C3.

Applications

- Surface water monitoring
- Water purifiers
- Water treatment plants

Hardware features, software features and functions UV Meter COD

Measuring ranges	0÷200 mg/L – 0÷800 mg/L – 0÷2.000 mg/L – 0÷5000 mg/L – 0÷20000 mg/L other on request	
Measuring principle	UV spectrophotometry	
Analysis frequency	Settable	
Accuracy	10% of f.s.	
Drift	on zero 5%	Full range 10%
Temperature	Ambient > 0÷50°C	Sample > 0÷80°C
Analogue output	4÷20 mA	
Serial output	RS232	
Alarms	4 relays	
Data logger	Built-in – data download via RS232	
Power supply	110÷130 Vac or 220÷240 Vac/30 VA/ 50÷60 Hz; 12÷15 Vdc 3A	
Dimensions (L x H x P)	600 x 420 x 230 mm	
Weight	Approx. 20 kg	
Peculiarities	Interference in the presence of chlorides	No
	Reagents or consumables	No
	Filtration	Not necessary
	Self-cleaning	Integrated
	Operating costs	Extremely limited

Controllers

Sensors

Analysers

Samplers

Flow

Level

Pressure

Web App

Remote control

Data logging

Accessories

NITRATE ANALYZER

Controllers

Sensors

Analysers

Samplers

Flow

Level

Pressure

Web App

Remote control

Data logging

Accessories

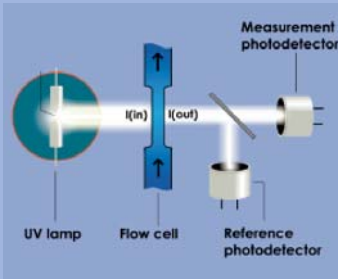

The measuring principle is based on the intense UV absorption of the NO chromophore at 210-220 nm according to the Lambert-Beer law:

$$[C] = k \cdot \log \left(\frac{I_{in}}{I_{out}} \right)$$

[C]: sample concentration

k: extinction coefficient

I_{in} : intensity of light input sample

I_{out} : intensity of light output sample

An automatic linearization stored in the analyzer is used to compensate the nonlinearity of the Lambert Beer law for high concentrations.

The measurement is the weighted sum of the concentrations of NO₂ and NO₃, although, in most applications, the concentration of NO₂ is negligible compared to that of NO₃.

Turbidity, organic substances, suspended solids or dirt into the measuring cell are automatically compensated by means of a differential measurement with a second detector at a different wavelength.

Applications

Surface water monitoring
Water purifiers
Water treatment plants

Hardware features, software features and functions UV Meter NITRATE

Measuring ranges	0 ÷ 30 mg/L – 0 ÷ 100 mg/L – 0 ÷ 250 mg/L	
Measuring principle	UV spectrophotometry	
Analysis frequency	Settable	
Accuracy	5% of f.s.	
Drift	on zero 5%	Full range 10%
Temperature	Ambient > 0÷50°C	Sample >0÷80°C
Analogue output	4÷20 mA	
Serial output	RS232	
Alarms	4 relays	
Data logger	Built-in – data download via RS232	
Power supply	110÷130 Vac or 220÷240 Vac/30 VA/ 50÷60 Hz; 12÷15 Vdc 3A	
Dimensions (L x H x P)	600 x 420 x 230 mm	
Weight	Approx. 20 kg	
Peculiarities	Interference in the presence of chlorides	No
	Reagents or consumables	No
	Filtration	Not necessary
	Self-cleaning	Integrated
	Operating costs	Extremely limited

ANALYZERS FOR HYDROCARBONS IN WATER

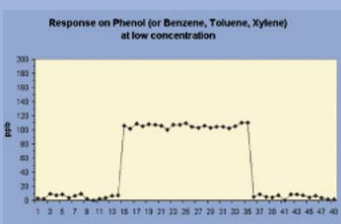
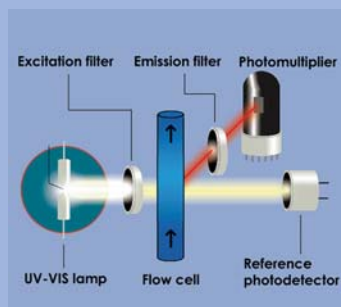

The measuring principle is based on the UV fluorescence.

Thanks to the use of a high sensitivity photomultiplier, even very low concentrations can be determined (of the order of micrograms/litre).

The table shows the relative intensity measurements of certain aromatic hydrocarbons:

Anthracene	42
Benzene	10
Biphenyl	20
Chlorobenzene	7
Fluorobenzene	10
Naphthalene	35
Phenanthrene	25
Phenol	18
Propylbenzene	17
Styrene	10
Toluene	17
Xylene	22

Applications

Aromatic hydrocarbons in water (BTEX, PAH, phenol, oil, fuel etc.)

Surface water

Yard water

Ground water

Underground water

Cooling water

Drinking water

Process water

Hardware features, software features and functions UV Meter HYDROCARBONS

Measuring ranges	0 ÷ 1 mg/L – 0 ÷ 10 mg/L – 0 ÷ 100 mg/L – 0 ÷ 1000 mg/L (other on request)	
Measuring principle	Fluorescence	
Repeatability	±0.1 ppm ± 1 ppm	
Accuracy	10% of f.s.	
Drift	on zero 5%	Full range 10%
Temperature	Ambient > 0÷50°C	Sample > 0÷80°C
Analogue output	4÷20 mA	
Serial output	RS232	
Alarms	4 relays	
Data logger	Built-in – data download via RS232	
Power supply	110÷130 Vac or 220÷240 Vac/30 VA/ 50÷60 Hz; 12÷15 Vdc 3A	
Dimensions (L x H x P)	600 x 420 x 230 mm	
Weight	Approx. 20 kg	
Peculiarities	Interference in the presence of chlorides	No
	Reagents or consumables	No
	Filtration	Not necessary
	Self-cleaning	Integrated
	Operating costs	Extremely limited

Controllers

Sensors

Analysers

Samplers

Flow

Level

Pressure

Web App

Remote control

Data logging

Accessories

CONTINUOUS T.O.C. ANALYZER

Controllers

Sensors

Analysers

Samplers

Flow

Level

Pressure

Web App

Remote control

Data logging

Accessories

Features and advantages

Continuous measurements of TOC / DOC in water

Method compliant with US- EPA 415-2

Automatic calibration

Control with industrial PC

Dual channel measurement (optional)

Possibility of measurement expressed as COD (related to TOC)

Generator of purified air (optional) (Carrier Gas)

Humidity sensor (optional) (NDIR-Detector Protection)

Pressure sensor (optional) (Pressure Control System)

The **UV TOC Meter** is a continuous analyzer for the determination of total carbon (TC), total organic carbon (TOC) or dissolved organic carbon (DOC) according to the US-EPA Standard Method 5310C.

By using the UV-Persulfate method provides highly accurate measurements of TOC in the low ranges (up to 1 ppb for pure water), for drinking water and surface water.

A typical application is the continuous monitoring of critical phases of industrial processes to ensure the safety of production processes and to guarantee the quality of the produced goods. Typical users are the chemical and pharmaceutical industries, food, electronics, but also the untreated wastewater.

UV TOC Meter

Analytical method

The untreated sample is mixed with the carrier gas (air) and the oxidation reagent (Sodium Persulfate) and then conveyed through the UV reactor.

The CO is measured in a NDIR-Detector (Non Dispersive Infrared Detector) and displayed as TC content in ppm C or mg/L C.

TOC / DOC

For the determination of TOC / DOC it is used direct method or more precisely the NPOC method (Non Purgeable Organic Carbon).

To measure the NPOC content, sample analysis is performed in a multi-step process. The sample flows continuously into the analyzer. In the first phase the sample is acidified with sulphuric acid to reach a pH value < 2 and purged with gas to remove the inorganic carbon.

During this phase, the "purgeable" carbon potentially existing (POC) is removed. From this point the sample consists of "not purgeable" organic carbon (NPOC).



In the next step the sample (free from inorganic carbon) is pumped into the reactor where it is exposed to ultraviolet light.

The UV radiation together with the concentrated persulfate, which is also pumped into the reactor, completely oxidizes the organic carbon compounds (NPOC) into CO₂.

When leaving the reactor, the CO₂ flow passes through the gas-liquid separation device before entering the high sensitive infrared detector (NDIR), which measures the CO₂ concentration.

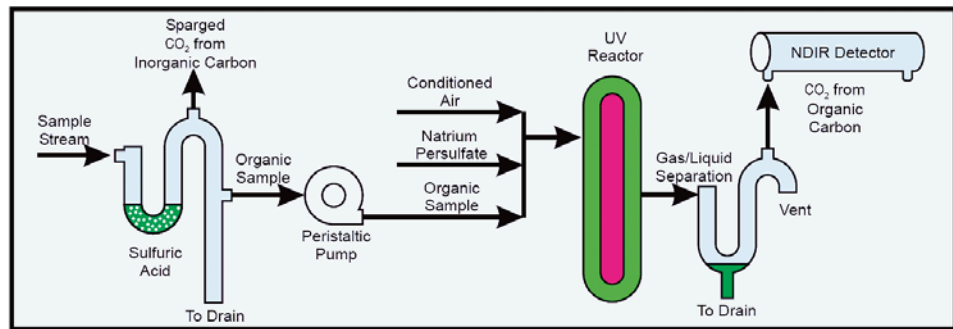

An on-board controller will process the data of the NDIR detector to calculate the concentration in mg/ or ppm.

The sophisticated gas and liquids calibration functions ensure accurate results.

Hardware features, software features and functions UV TOCMeter

Measurement	Total Carbon (TC) or alternatively Total Organic Carbon (TOC / DOC) with stripping of inorganic carbon
Method	Photochemical Oxidation with determination of CO ₂ with NDIR
Measuring ranges	0.1 ÷ 1 ppm ; 0.5 ÷ 10 ppm ; 1 ÷ 50 ppm ; 10 ÷ 100 ppm ; 50 ÷ 500 ppm ; 100 ÷ 1,000 ppm
Display	Graphic LCD Backlit
Interface	Auto-start function, self explanatory software, with integrated help system. Automatic maintenance control.
Hydraulic connections	sample, discharge: tube 30 mm ID
Power supply	230 / 115 V~, 50 / 60 Hz
Analogue output	0/4 ÷ 20 mA
Serial port	(RS 232) for remote control
Status outputs	4 relays for malfunctions, life-zero
Remote control	via TCP/ IP protocol (internet)
Serial port	(RS 232) for remote control
Status outputs	4 relays for malfunctions, life-zero
Housing	Stainless Steel Cabinet IP 54
Dimensions	(L x H x P) 746 x 600 x 420 mm
Weight	45 kg
Optional	Stainless Steel Cabinet, IP 65, ATEX zone 1 and zone 2

FILTRATION SYSTEM FOR ANALYZERS

Controllers

Sensors

Analysers

Samplers

Flow

Level

Pressure

Web App

Remote control

Data logging

Accessories

Self-cleaning filter **SF-100**

The filtration system SF-100, often used upstream of a line analysis systems, is a self-cleaning device that uses compressed air with programmable frequency to maintain the stainless steel filter element clean.

While most of the liquid under analysis goes much faster through the polypropylene filter body, only the amount needed by the analyzer is filtered through the stainless steel special profile filter element. This prevents a rapid accumulation of dirt and deposits on the filter.

In addition to this, the filtration system uses an electronic timer that periodically, at intervals programmed by the user, provides the opening of the NC of the three-way solenoid valve allowing the entry of compressed air at suitable pressure, which provide a powerful backwash of the filter. This proves to be a very effective backwashing to remove trapped particles on the outer surface of the filter.

The frequency and duration of the automatic washing cycle can be programmed by the user in a wide range of values.

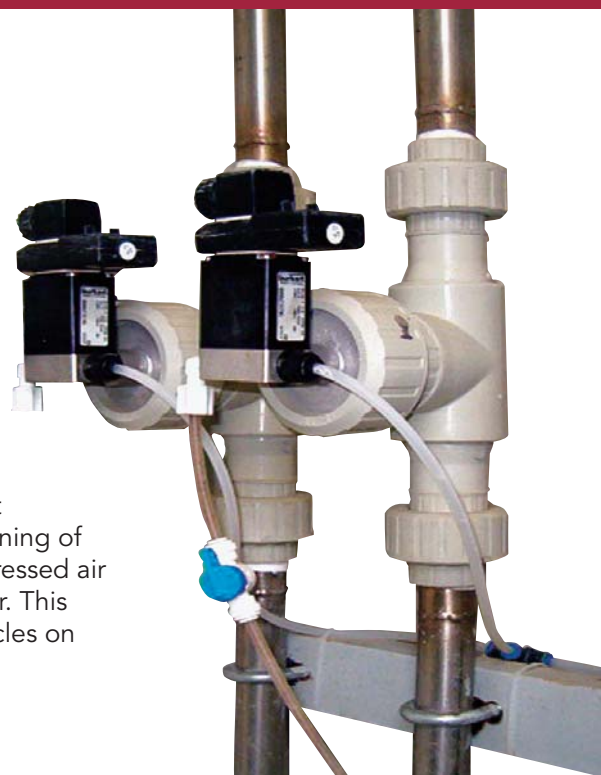

Technical specifications SF-100

Filter body material	PP (polypropylene)
Filter element	Stainless Steel AISI 316 – Passage size 100 micron
Solenoid valve	Parts in contact with the liquid SS AISI 316 - Viton
Protection grade	Timer and Solenoid valve IP 65
Filter weight	1 kg
Temperature	Sample and Ambient 2 ÷ 55°C
Pressure	Minimum sample line 0.3 Bar Maximum sample line 2.5 Bar Backwashing compressed air pressure minimum 20% above sample line pressure, up to 3 bar max.
Flow	Minimum sample line flow 0.1 mc/h Filtered sample 0.1 - 2 L/min depending on the sample line pressure
Hydraulic connections	for input/output filter 1" NPT Compressed air inlet connection for washing tube ¼"
Power supply	220-240 Vac
Power consumption	20VA
Washing frequency	Programmable from 1 to 45 min
Washing time	Programmable from 1 to 30 sec.



Immersion filtration system UF-TEC

UF-TEC is a filtration system which allows sample feeding of COLOR TEC or similar analyzers.

It consists of a control panel and an immersion filtering element that can be installed in any section of a water treatment plant because its operation is independent of the sample condition: biological sludge, presence of foams, algae, bloated or floating sludge. Suction of the sample occurs using the peristaltic pump located inside the control panel, which is also used to push the filtered liquid to the analyzer.

Start of the peristaltic pump and duration of suction is controlled by the COLOR TEC analyzer in relation to the predetermined frequency of analysis and the distance between analyzer and the sampling point. A cleaning system is provided, controlled by the analyzer or through a timer (optional), which by means of a compressor and a 3-way valve directs, on the same sampling tube, pressurized air which allows to purge both the line and the pipes of the filtering element.

Technical specifications UF-TEC

Components	Wall mounting control panel; Immersion filter candle; Suction / delivery tube 10m
Filtration	Porosity approx. 0.02 μ m
Temperature	Capacity 1L/h with a 3m head between control panel and candle filter Sample 4 \div 40°C; Ambient 4 \div 45°C, max humidity 95% non-condensing
Installation conditions	<ul style="list-style-type: none"> ■ Maximum mounting depth of the candle filter: 2m ■ Maximum distance Control panel - Candle filter: 10m ■ Maximum distance Analyzer - Control panel: 5m ■ Maximum head Control panel - Candle filter: 5m ■ Maximum head Analyzer - Control panel: 5m
Cleaning system	Integrated with compressed air at 4 bar. Automatic control from COLOR TEC analyzer or timer (opt.)
Materials	Control panel made of ABS
Candle filter	Body housing of white PVC-U ; Covers made of Noryl GTX Filtering material PESM
Suction tube	PE
Power supply	220 Vac – Power consumption 50 VA
Dimensions	Control panel (lxhxp) 900 x 600 x 300 mm – Weight 10 kg Candle filter (lxØ) 425 x 95 mm – Weight 4 kg

SAMPLING SYSTEMS

Controllers

Sensors

Analysers

Samplers

Flow

Level

Pressure

Web App

Remote control

Data logging

Accessories



Chemitec markets MAXX GmbH sampling systems in Italy. This company's experience, gained over the last 20 years, means that it is now possible to offer a wide range of equipment and technical solutions for operation in a variety of system conditions

- Wide range of models, for fixed installation or portable
- Electronic control unit is the same for all models in the range
- Internal data logger for storing sampling and fault data.
- Possibility to connect to a remote PC for programming or data download.

Electronic control unit

Microprocessor control, Sleep-Mode (<5 mA), power supply 8-16 V, membrane keyboard (with 0-9, ESC, ORL, cursor keys), graphic display (128 x 64 pixel), backlight

Mini-USB interface, RS422/485, RS 232; Ethernet RJ45 (Optional)

Optional communication Modbus, connection via PROFIBUS DP; LAN / WLAN through TCP / IP RJ45, with IE-Browser, 4-32GB SD / SDHC memory

Analogue input 0/4 ÷ 20 mA

Digital inputs for remote control, event and pulse launch flow meter

Digital outputs for reporting status and faults

Programming

Twelve (12) different sampling programs that can be set freely, with linking programs function

In relation to time range between 1' and 99h 59' with 1 minute step

In relation to flow using a flow meter with a 0/4 -20 mA analogue or digital output

In relation to an event contact activated by set point from pH, °C, Conductivity, Oxygen meters etc., also in combination with time and flow rate

Filling each bottle in relation to time or number of samples

Memorisation of the sampling and fault events with date and time and possibility of **remote data acquisition and programming** via serial port, LAN, UMTS/GPRS modem with dedicated software (optional)

Sampling system

Dosage system

Vacuum pump 20÷350 ml or 20÷250 ml

VAR (variable) vacuum pump 5÷ 250 ml

Peristaltic pump 20 ÷ 10.000 ml

Accuracy Vacuum pump : < 2.5 % or ±3 ml;
Peristaltic pump ±5 % or ±5 ml

Suction speed >0.5 m/s at a height of 7.8 m (at 1013hPa); the pump capacity can be electronically adjusted

Maximum suction height 8 m

Sampling mode Time, flow, event, manual sampling, variable volume proportional to the flow

Motorised torsion discharge valve with no interruption of the discharge pipe, open at the front with no parts in contact with the liquid

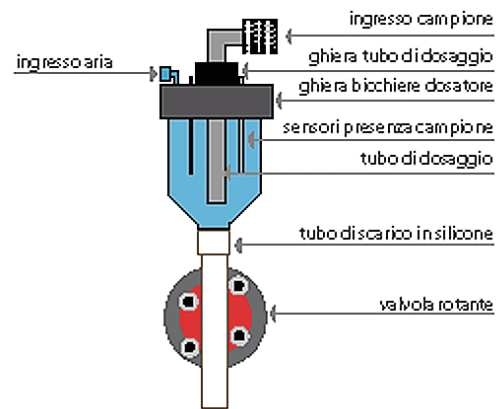

Thermostat-controlled and self-draining stationary samplers

SP5 B Thermostat-controlled stationary sampler in Plastic Container

Housing	PE material with 50mm insulation / PS/PC (GF10)
Upper part	Control unit and dosing unit with lid
Lower part	Distribution system and sample collection bottles, with door and handle with lock, insulated
Dimensions	1100 (1640 with lid open) x 760 x 7450 mm
Weight	approx. Kg. 75 (with a single bottle)
Operating temp.	Ambient -20 ÷ 40°C ; Sample 0 ÷ 40°C
Power supply	230V – 50/60Hz. ; Consumption 350VA
Standard bottles included	1X25L of PE; 4X14L of PE; 12X2.9L of PE; 12X2L of Glass; 24X1L of PE; S24X1L- of Glass (other on request)



SP5 S Thermostat-controlled stationary sampler in stainless steel cabinet

Housing	Two (2) separate stainless steel 1.4301 compartments, each with door and lock
Upper part	Control unit and dosing unit, with door and window, upper canopy made of plastic material (Styrosun) can be opened for inspection and maintenance
Lower part	Distribution system and bottles for collecting the samples with blind door, double wall insulation, thermostat-controlled
Dimensions	1290 (1890 with canopy open) x 690 x 645 mm
Weight	approx. Kg. 90 (with a single bottle)
Operating temp.	Ambient -20 ÷ 40°C ; Sample 0 ÷ 40°C
Power supply	230V – 50/60Hz. ; Consumption 350VA
Standard bottles included	1X25L of PE; 1X50L of PE; 2X10L of PE; 4 S 4X6L PE; 4X10L PE; 4X14L of PE; 12X2.9L of PE; 12X2L of glass; 24X1L of PE; S24X1L- of glass (other on request)



SAMPLING SYSTEMS

Controllers

Sensors

Analysers

Samplers

Flow

Level

Pressure

Web App

Remote control

Data logging

Accessories

SP5 A

Thermostat-controlled self-draining stationary sampler in stainless steel cabinet

Housing	Two (2) separate stainless steel 1.4301 compartments, each with door and lock.
Upper part	Control unit and dosing unit, with door and window, upper canopy made of plastic material (Styrosun) can be opened for inspection and maintenance
Lower part	Distribution system and bottles for collecting the samples with blind door, double wall insulation, thermostat-controlled
Dimensions	1290 (1930 with lid open) x 690 x 645 mm Version with 24 bottles of 2L 1400 (2175 with canopy open) x 800 x 850 mm
Weight	Kg 115 version with 2 bottles; greater for versions with more bottles
Operating temp.	Ambient -20 ÷ 40°C ; Sample 0 ÷ 40°C
Power supply	230V – 50/60Hz. ; Consumption 350VA
Standard bottles included	2X10L of PE; 4X5L of PE; 12X1.6L of glass; 16X2L of glass; 24X2L of glass (other on request)



Portable samplers and sampling heads

P6

Portable compact unit. Available with distributor and various types of bottles.

Housing	Double wall, lower part insulated (P6 L) with ABS
Dimensions	P6 L 500 x 740 millimeters (diam xh.) P6 Mini Maxx (. Ø x h) 400 x 605 millimeters
Weight	P6 L approx. 15 kg – P6 Mini Maxx approx. 10 kg
Operating temp.	Ambient 0 ÷ 45°C ; Sample 0 ÷ 40°C
Power supply	230V – 50/60Hz. ; Consumption 350VA
Standard bottles included	P6 L: of PE 24 x 1 L / 1 x 10 L / 4 x 4 L / 8 x 2 L ; of glass 24 x 350 ml / 12 x 950 ml / 8 x 2 L P6 Mini Maxx: of PE: 1 x 10 L; of glass: 1 x 4 L



TP5 W

Sampling head for wall mounting

Housing	Electronic control unit, suction and dosing unit, assembled in a PS/PC (GF 10) plastic structure for wall mounting
Dimensions	362 x 442 x 222 mm – Weight approx. 10 Kg.
Control unit	Inserted in IP 65 container Microprocessor with 128KB Eprom, 32KB di ram, 16KB Eeprom. 16 digital I/O , 8 analogue I/O. Real-time clock Waterproof keypad – Display LCD 4 x 20 backlit
Power supply	230 / 115 Vac – Power consumption approx. 25VA



TP5 C

Compact portable sampler

Housing	PE/PC (GF10) consisting of 3 parts Base containing the bottles, insulated (40 mm), with possibility to insert ice to refrigerate the samples Control and sample dosing unit Lid with latches
Dimensions	787 x 510 x 468 mm – Weight approx. 23Kg
Operating temp.	Ambient 0 ÷ 45°C ; Sample 0 ÷ 40°C
Power supply	Electronic control unit, suction and dosing unit: 12VDC with internal rechargeable battery or direct from the mains via battery charger
Autonomy	with battery fully charged, at least 2000 sampling operations in the following conditions: ambient temp. 20°C, sampling depth 1.5 m, sampling interval 1 min.
Standard bottles included	1X13L of PE; 1X25L of PE; 4X5L of PE; 16X1L of PE; 24X1L of PE



TP5 P

Portable sampling head

Housing	Electronic control unit , suction and dosing unit, assembled in a PS/PC (GF 10) plastic structure with carrying handle
Optional	Optional ISOBOX insulated container for bottles with passive or active cooling
Dimensions	Sampling head 442 x 452 x 222 mm Weight approx. 12Kg battery included Container for bottles ISOBOX 534 x 510 x 430 mm – Weight approx. 12Kg Active ISOBOX 775 x 550 x 468 mm Weight approx. 24Kg
Operating temp.	Ambient 0 ÷ 45°C ; Sample 0 ÷ 40°C
Power supply	Electronic control unit, suction and dosing unit: 12VDC with internal rechargeable battery or direct from the mains via battery charger
Autonomy	with battery fully charged, at least 2000 sampling operations in the following conditions: ambient temp. 20°C, sampling depth 1.5 m, sampling interval 1 min.
Standard bottles included	1X13L of PE; 1X25L of PE; 4X5L of PE; 16X1L of PE; 24X1L of PE

